



### DESCRIPTION:

### 75.6-76.8W AC-DC DIN RAIL Power Supply

The rated output power of PPR/SDR-75-XS series is 75.6-76.8W, input voltage range 85-264VAC, output voltage : 12V, 24V, 48V, High reliability, precision, efficiency, ultra-small size, stable output voltage and etc., with short circuit & overload protection, Widely used in telecommunications, industrial control, instrument, data acquisition, signal control, New Energy, Security, and other electronic systems.

### FEATURES

AC input 85VAC-264VAC, DC input: 127-360VDC	Built-in DC OK relay contact, Excellent Partial Load Efficiency	Operating temperature -25°C~70°C
Mounting track: TS-35/7.5 or TS-35/15	Protection: short circuit, over-load, over-voltage, over-temperature	Mini width: 32mm
RoHS complaint	High reliability, efficiency, 100% full load burn-in test	Built-in current limiting circuit
Built-in active PFC, PF>0.95	Easy Fuse Tripping due to High Overload Current	150% peak load capacity

### SELECTION GUIDE

Part Number	Input Voltage			Output				Efficiency @25°C, (Typ) %
	(VAC)		(VDC)	Voltage (VDC)	Pre-set voltage @25°C (V)	Rated current (A)	Rated power (W)	
	Rated	Range	Rated					
PPR/SDR-75-12S	220	85-264	127-360	12	12.00-12.10	6.3	75.6	88
PPR/SDR-75-24S	220	85-264	127-360	24	24.00-24.20	3.2	76.8	91
PPR/SDR-75-48S	220	85-264	127-360	48	48.0-48.40	1.6	76.8	91

All specifications typical at TA=25°C, nominal input voltage and rated output current unless otherwise specified.

### OUTPUT CHARACTERISTICS

Conditions	Conditions	Parameter
Output voltage regulation	12V output voltage	12-14V
	24V output voltage	24-28V
	48V output voltage	48-56V
Rated Output current	12V output voltage	6.3A at 12V
		5.7A at 14V
	24V output voltage	3.2A at 24V
		2.85A at 28V
	48V output voltage	1.6A at 48V
		1.34A at 56V
Rated Output power	12V output voltage	75.6W/12V, 80W/14V
	24V output voltage	76.8W/24V, 80W/28V
	48V output voltage	76.8W/48V, 80W/56V
Ripple&Noise 0<Ta≤70°C	12V output voltage	≤100mVp-p
	24V 48V output voltage	≤120mVp-p
Ripple&Noise -25<Ta≤0°C	12V output voltage	≤200mVp-p
	24V 48V output voltage	≤240mVp-p
Capacitive load capacity	12V output voltage	3000uF
	24V output voltage	2250uF
	48V output voltage	1000uF
Line regulation @-25~70°C	± 0.5%	
Load regulation @-25~70°C	± 1.0%	
Temp. coefficient @-25~70°C	± 0.03%/°C	
Set-up time @25°C	≤250mS@230Vac input ≤500mS@100Vac	
Hold-up time @25°C	≥20mS@(230Vac input, Full load)	
Overshoot&Undershoot	<5.0%	

## INPUT CHARACTERISTICS

Conditions	Parameter
Rated Input voltage range	100VAC~240 VAC
Input voltage range	85VAC~264 VAC (300vac Max.)
input voltage range	127VDC-360VDC
Frequency Range	47Hz~63Hz
Set-up voltage @-25~70°C	<85 VAC <127VDC
Input current @25°C	<0.95A/100VAC, <0.45 A/230VAC ; 0.77A/130VDC 0.29A/300VDC
Inrush current @25°C	<30A@100 Vac input <60A@230Vac input

## PROTECTION

Conditions	Parameter	Notes
Over-Load (12Voutput)	110%~150% of rated current	Constant power limiting for some time(150% of rated current, last 3S) then PS stop working for 7S,after 7S,if the load <=rated current, PS will work normally, auto recovery
Over-Load (24Voutput)	110%~150% of rated current	
Over-Load (48Voutput)	110%~150% of rated current	
Over-voltage (12Voutput)	15~18V	Hiccup mode, Auto recovery
Over-voltage (24Voutput)	29~33V	
Over-voltage (48Voutput)	58~65V	
Over-temperature	100±5°C, detect on heat sink of power transistor, shut down O/P, auto recovery after temperature goes down.	
Output short circuit protection	Long-term model , auto recovery	

## ENVIRONMENT CHARACTERISTICS

Conditions	Parameter
Operating amb. Temp.&Humi. (12V output)	-25°C~70°C; 20%~90%RH No condensing 60°C~70°C 2W/°C derating
Operating amb. Temp.&Humi. (24V output)	-25°C~70°C; 20%~90%RH No condensing 60°C~70°C 2W/°C derating
Operating amb. Temp.&Humi. (48V output)	-25°C~70°C; 20%~90%RH No condensing 60°C~70°C 2W/°C derating
Storage Temp. & Humi.	-40°C~85°C; 5%~95%RH No condensing
Vibration	10 ~ 500Hz, 2G, 10min./1cycle, each along X,Y, Z axes IEC 60068-2-6
Pulse	20G/11mS pulse ,3 times at each X,Y,Z axes IEC 60068-2-27
Altitude	6000m

## SAFETY&EMC STANDARDS @25°C

Conditions	Parameter
Safety Standards	meet UL508, UL60950, EN60950
Withstand Voltage	I/P-O/P:3.0KVac/10mA; I/P-FG:2.5KVac/10mA; O/P-FG:0.5KVdc/20mA O/P- DC OK :0.5KVdc/1mA Test time:1min.
Isolation resistance	I/P-O/P: 10M ohms; I/P-FG : 10M ohms; O/P-FG : 10M ohms
Grounding test	Test condition: 32A / 1min Grounding resistance: <0.1 ohms
Leakage Current @ 25°C	I/P-Grounding≤3.5mA; I/P-O/P ≤0.25mA (264Vac input, 63Hz)
EMC emission	Compliance to EN55022, EN55024, FCC PART 15 CLASS B
EMC immunity	Compliance to EN61000-4-2,3,4,5,6,11 heavy industry level
Harmaonic current	EN61000-3-2, CLASS A

### OTHERS

Conditions	Parameter		
Net Weight	0.53kg	Dimension (H*D*W)	124*119*32mm
Cooling method	Cooling by free air flow		
Series / parallel function	yes		
DC OK relay contact rating	Max 30V/1A or 60V/0.3A or 30Vac/0.3A Resistive load		
DC OK LED	V On: when output voltage is up to 90% of rated output voltage, V Off: when output voltage is down to 80% of rated output voltage		

### RELIABILITY CHARACTERISTICS

Conditions	Parameter
MTBF	300, 000Hrs AT 25°C, MIL-217 Method 2 Components Stress Method

### MECHANICAL DIMENSIONS

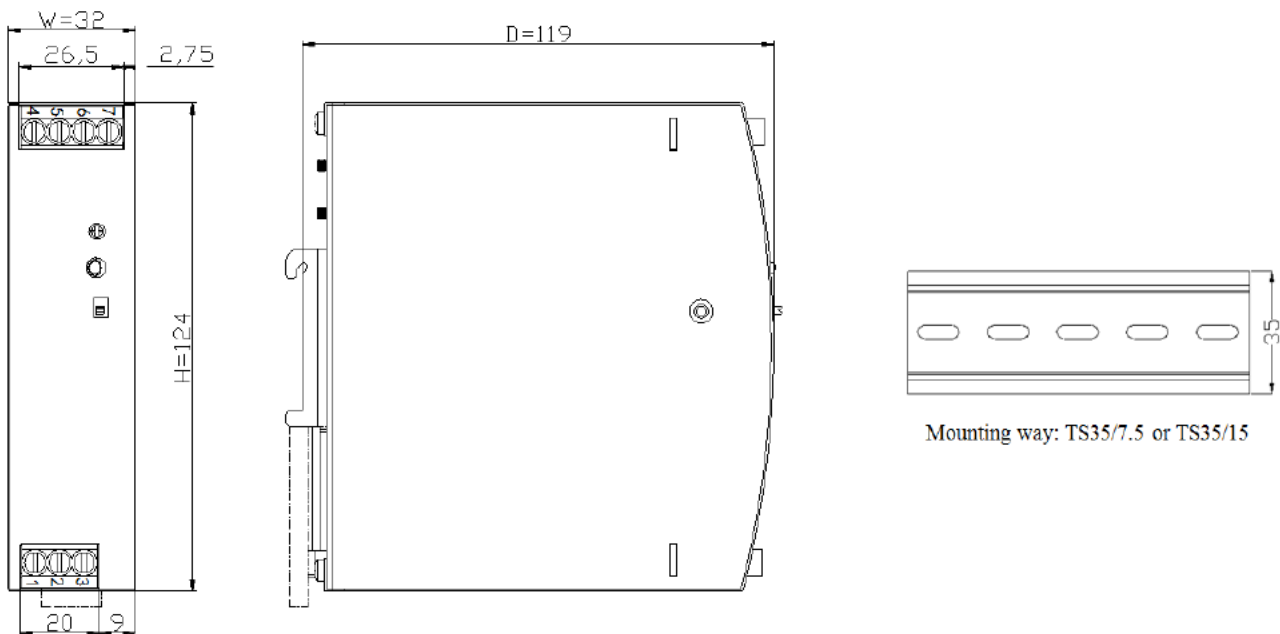

1.AC terminal blocks installation information			
Terminal No.	Function	Wire Spec	Recommended torque
1	L	20~10AWG	1Nm
2	N		
3	PG		

2.DC terminal blocks installation information			
Terminal No.	Function	Wire Spec	Recommended torque
4 & 5	DC OK Relay Contact	20~10AWG	1Nm
6	-V		
7	+V		

	AC/DC Terminal
Type	Screw terminal blocks
Solid Wire	0.5-6mm <sup>2</sup>
Strand Wire	0.5-4mm <sup>2</sup>
Wire Spec	AWG20-10 (PG wire >18AWG)
Max Wire Diameter	2.8mm
Recommended stripping length	7mm
Screwdriver	3.5mm Straight or Cross Screwdriver
Recommended Torque	1NM

### DERATING CURVE

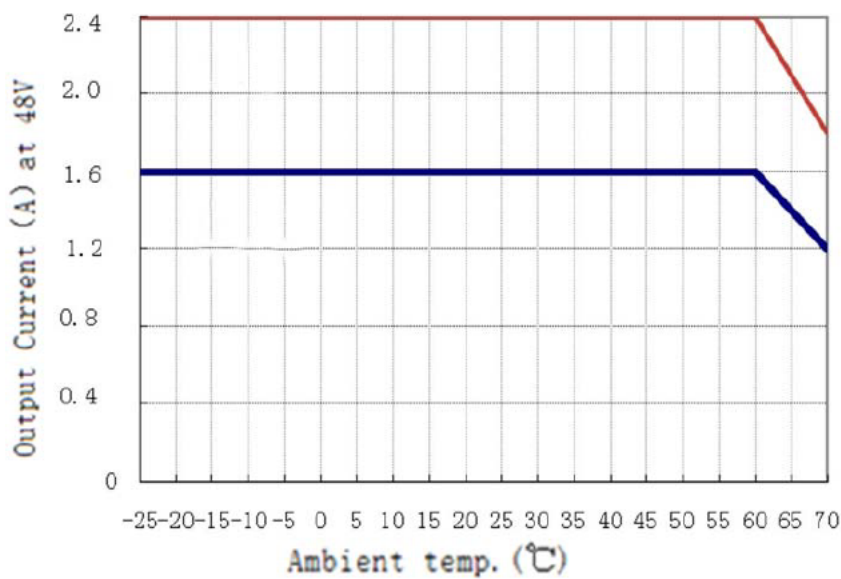
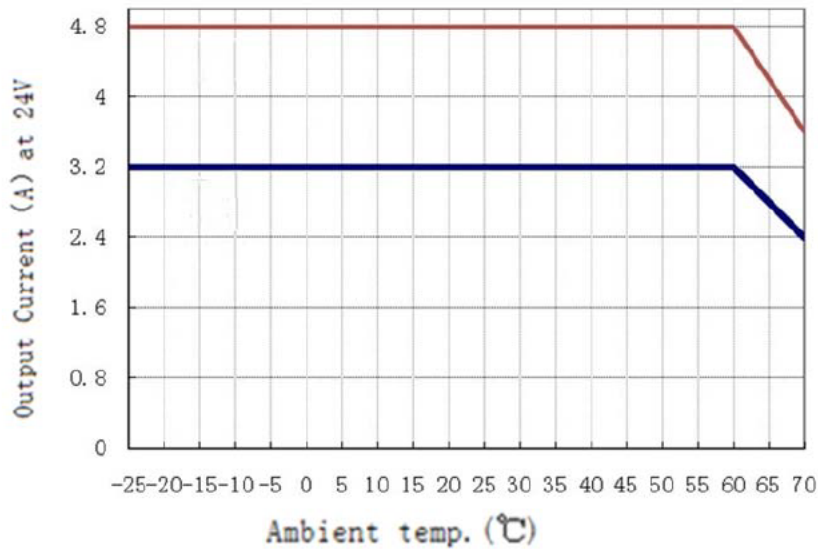
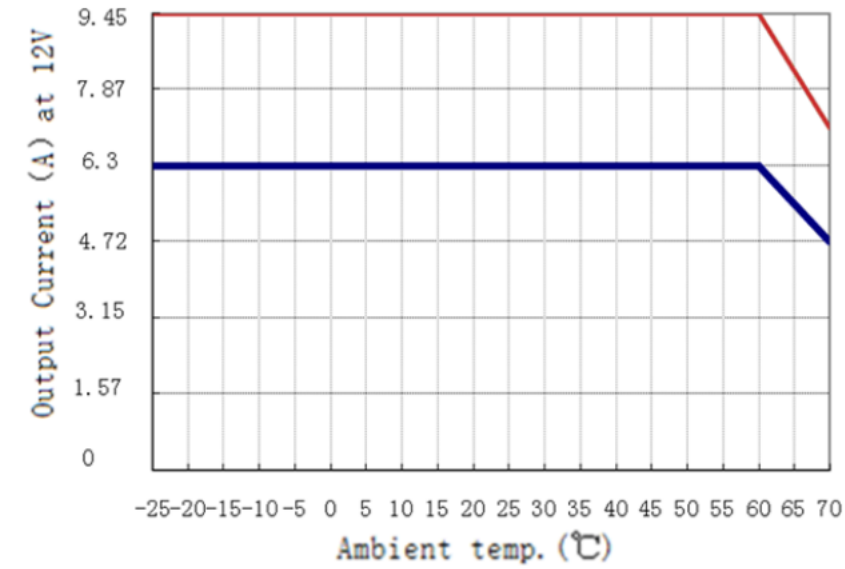

Short time working  
Continuous working

### MOUNTING METHOD INSTRUCTION

A1 is recommended output current, A2 is the allowed max output current (PSU lifetime is around half of A1)

#### 12V output

##### Mounting 1:

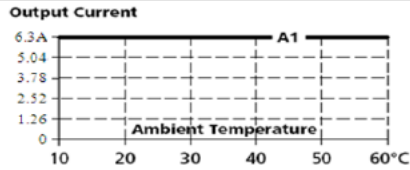
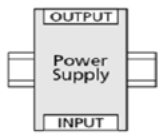

##### Mounting 2:

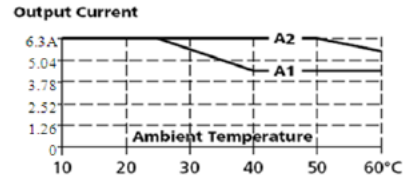
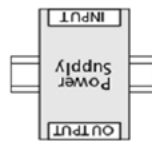

##### Mounting 3:

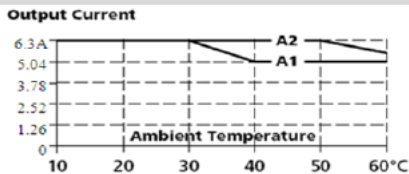
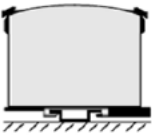

##### Mounting 4:

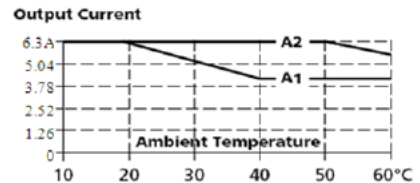
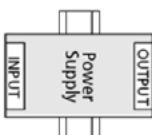

##### Mounting 5:

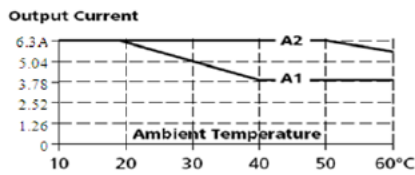
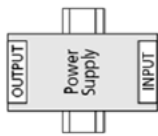

#### 24V output

##### Mounting 1:

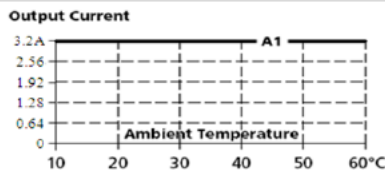
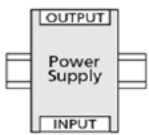

##### Mounting 2:

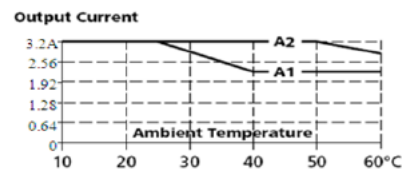
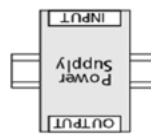

##### Mounting 3:

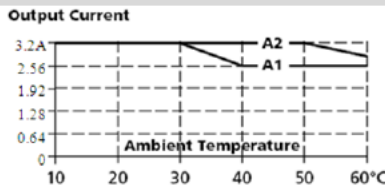

##### Mounting 4:

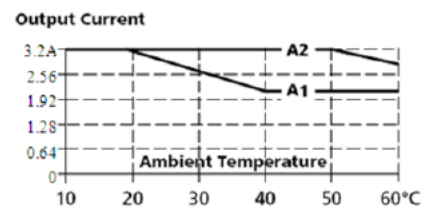
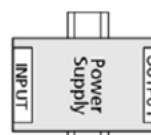

##### Mounting 5:

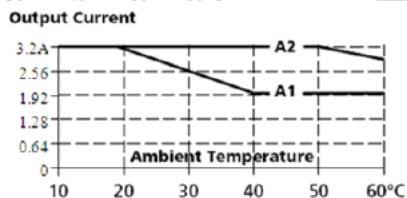
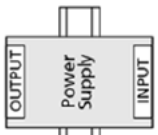

#### 48V output

##### Mounting 1:

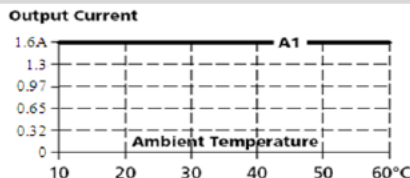
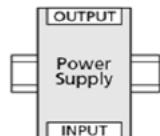

##### Mounting 2:

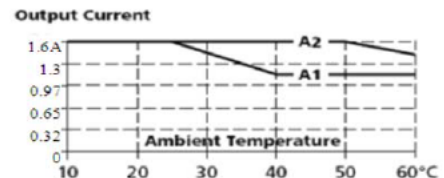

##### Mounting 3:

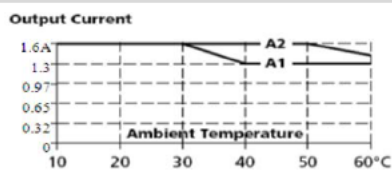
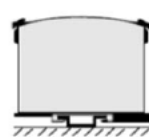

##### Mounting 4:

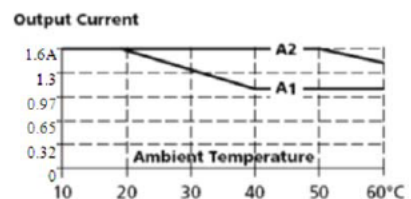
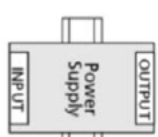

##### Mounting 5:

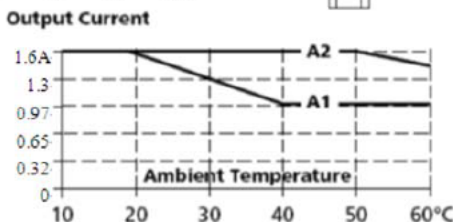
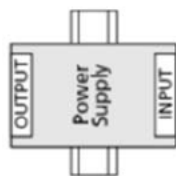

### BLOCK DIAGRAM

Functional diagram

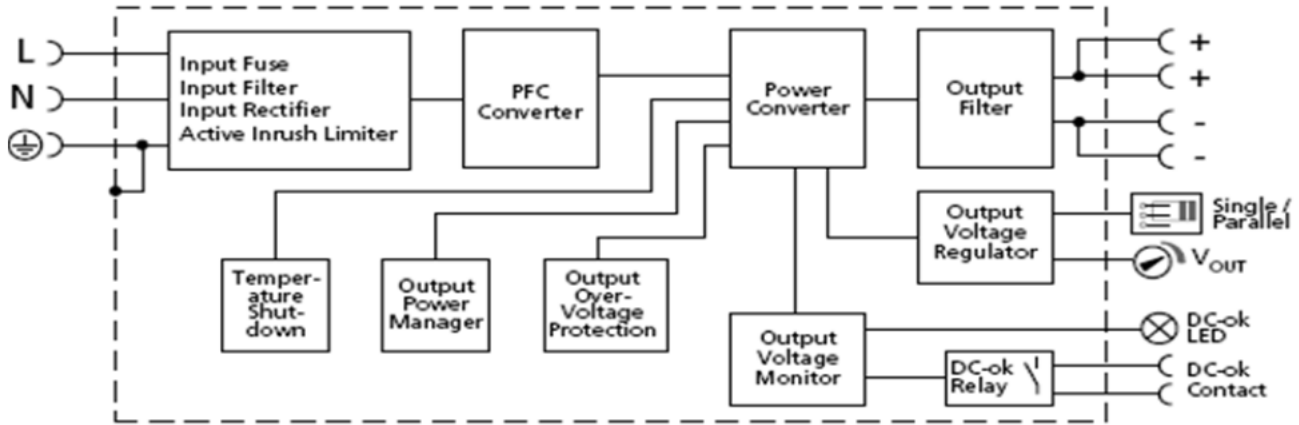

### MODEL SELECTION

**PPR / SDR - 75 - 12 S**

